

AUTOMATIC ELECTRIC GUN SERIES

AU-1G

适合年龄18岁以上使用

Users Restricted to 18 Years of age or older

操作手册指导手册

HANDLING CAUTIONS AND INSTRUCTION MANUAL

ENHANCE
**HOP
UP**
SYSTEM

操作之前先阅读这本手册

Always read through this manual before operation.



WARNING



Only for 18 years
old or up

Operation of this air gun for competition use is restricted to users younger than 18 years old.



Injury caution

Since the field of fire can be about 50 to 60 meters, careless shooting may cause eye damage or other injuries.



Careful reading of
Handling cautions and
Instruction manual

Always read through this HANDLING CAUTIONS AND INSTRUCTION MANUAL carefully before operation. Operate the air gun with full recognition of warnings and cautions.

Always read this manual before using.

AUTOMATIC ELECTRIC GUN SERIES



A47
ELECTRIC AIR GUN



A47-03
ELECTRIC AIR GUN



A47-B
ELECTRIC AIR GUN

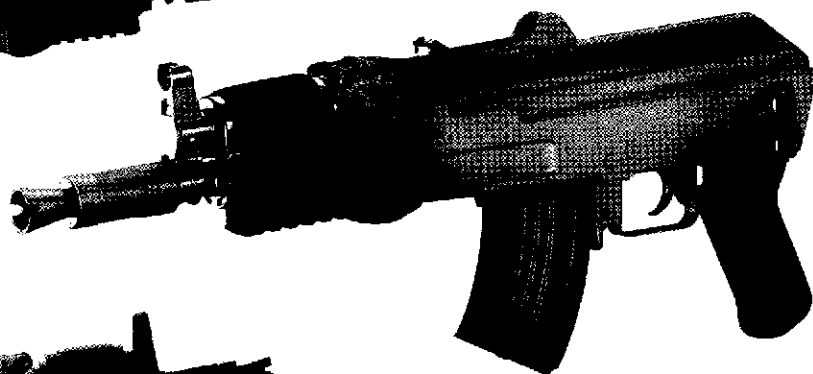

A47-B
ELECTRIC AIR GUN

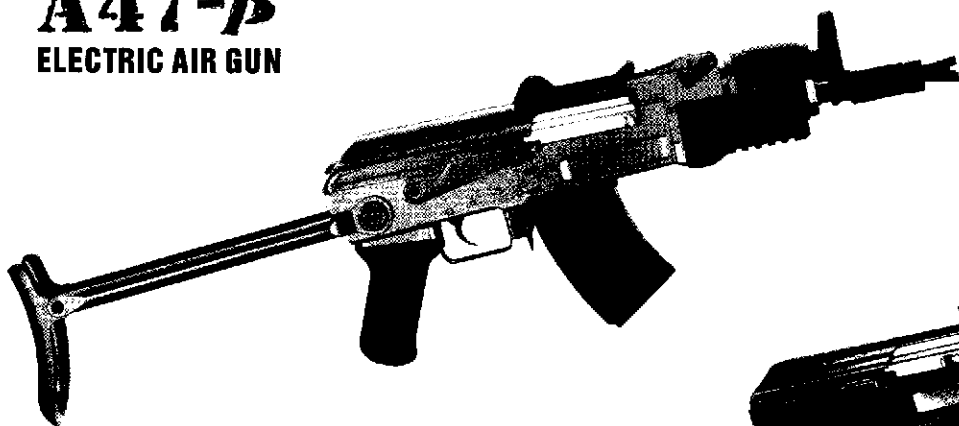

A47-B-F
ELECTRIC AIR GUN

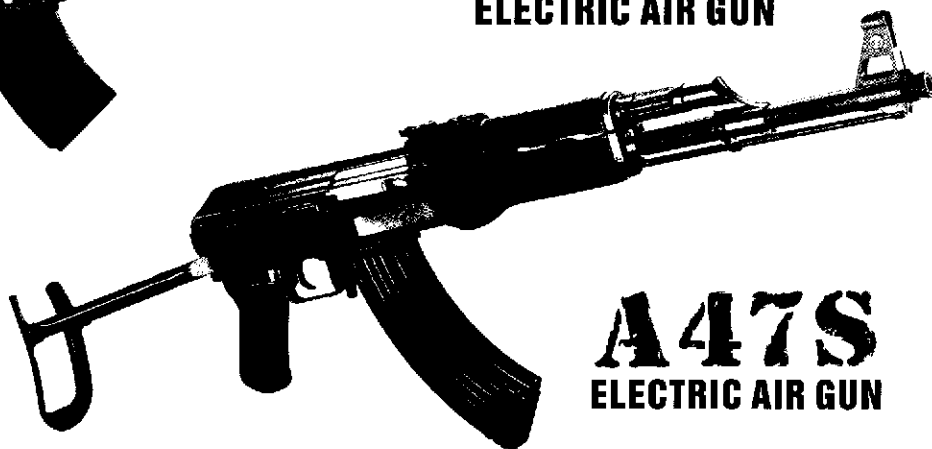

A47S
ELECTRIC AIR GUN

AUTOMATIC ELECTRIC GUN SERIES



G608
ELECTRIC AIR GUN



M5-J
ELECTRIC AIR GUN



M5-S6
ELECTRIC AIR GUN



M5-A4
ELECTRIC AIR GUN



M5-S5
ELECTRIC AIR GUN



WARNING

警告

<INSTRUCTION> PLEASE READ IT BEFORE USE IT.

<使用注意書> 使用之前請務必閱讀。

It is for you to enjoy the fun of shooting that this soft ballistic gun is made. Various kinds of guns have their own features. So you should have sound comprehension before you enjoy the fun of safe shooting. The BB bullets can flight a distance Of 50-60m. If it is not properly used, there would be some risk. So you have to read the instructions carefully before using it, And strictly follow them while using it, and then, you can enjoy the fun of shooting.

製作此軟彈槍，是爲了讓您享受射擊遊戲的樂趣，各種各樣槍的特點，使用時的注意事項應詳細了解后才能享受安全運動射擊的樂趣。發射的BB彈能飛出約50-60M。如果使用不當，就有受傷的危險。用之前，一定要仔細閱讀注意事項（使用說明書），而且要嚴守規定，才能享受運動射擊的樂趣。

WARNING

警告

Please pay attention: you would probably be hurt because of carelessness or shooting mistake.

如果稍不留神或發射錯誤都有可能引起受傷的危險，請萬分注意！

WARNING
警告

MAKE SURE TO WEAR PROTECTION GLASSES TO PROTECT YOUR EYES.
一定要戴護目鏡以保護眼睛



Make sure to wear protection glasses while shooting BB bullets or playing game. What's more, the BB bullet will go back once it hits hard object, (attention: please don't train on people.)

發射BB彈或遊戲時，一定要戴護目鏡以保護眼睛。而且，BB彈一撞到硬的物體可能會反彈（注意：一定不能對著人發射BB彈）。

WARNING
警告

YOU MAY BE PUNISHED IF YOU SHOOT MISCHIEVOUSLY.
如果胡亂發射，可能會受到懲罰。

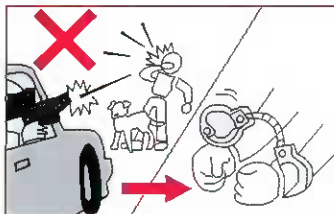

Those who shoot mischievously or train the gun on people or animals will probably be punished by law.

諸如胡亂發射，對著人或動物發射就有可能射傷他人，因此也有可能受到法律的懲罰。

WARNING
警告

DON'T LOOK CLOSE TO THE MUZZLE AT ANY TIME.
無論什麼時候都不能窺看發射口



Your eyes will be hurt if the BB bullets shoots your eyes by chance, it is very dangerous. So don't look close to the muzzle at any time.

如果BB彈剛好射中眼睛，可能會使眼睛受傷，非常危險。因此，無論什麼時候都不能窺看發射口。

WARNING
警告

THE MUZZLE SHOULD BE DIRECTION AT THE SAFE DIRECTION.
發射口，一定要對準安全的方向



The muzzle should not train on people or animals or any where that would cause danger. Please cover the lid except shooting.

發射口，絕對不能對準人、動物或其它危險的方向。除發射時以外，安全蓋一定要蓋住發射口。

YOU HAVE TO READ THE INSTRUCTION CAREFULLY BEFORE USING IT BECAUSE THE OPERATION IS DIFFERENT FROM THE NORMAL GUN.

因使用方法和一般的槍不同，所以一定要詳細了解后才能使用。

WARNING
警告

DON'T TRAIN ON PEOPLE AND ANIMALS.
不能對著人或動物發射



Please don't train the soft ballistic gun on people or animals. Please cover the muzzle with the safe lid, if you are not shooting. 請不要將軟彈槍對著人或動物發射。除了對準目標發射后，請將安全蓋蓋在發射口上。

WARNING
警告

THE SAFE LID SHOULD COVER THE MUZZLE.
安全蓋一定要蓋住發射口



The safe lid should be the same shape of the gun.
安全蓋不能像槍一樣的形狀

SAFE LID
安全蓋

Please cover the muzzle with the safe lid, so that the BB bullets won't be shot randomly.

爲了使BB彈不會隨意發出，發射口一定要蓋上安全蓋。

WARNING
警告

DON'T SHOOT CASUALLY.
不能隨意扣動扳機



Shoot casually will cause great danger, so please shoot before you take away the lid, and aim at the object.

不加注意而扣動扳機會引起極大危險。一定要取下安全蓋，對準目標后才能扣動扳機。

WARNING
警告

DON'T SHOOT WHERE THERE ARE PEOPLE OR TRANSPORTATION.
決不能在有人或車通過的場所發射



The soft ballistic shooting place should be in the safe arena.. those places where there are people or transportation are not allowed to shoot.

發射軟彈的場所，一定要在安全的場所。像人或車通過的場所，或周圍有人的場所決不能發射。

THOSE INCIDENT, DANGER, HURT, REPAIR CAUSED BY THE WRONG WAY OF OPERATION, READJUSTMENT, DISMANTLE ARE CLAIMED TO BE THE RESPONSIBILITY.

錯誤的使用方法，操作，改裝，拆散等引起的事故，危險，損傷，維修等都不是經銷商的責任。

Always read through this manual before operation. 在操作之前必需讀熟這些說明書

WARNING
警告

PLEASE PUT IT IN A BAG OR BOX WHILE CARRYING IT.
攜帶著走路時,一定要裝入盒子或包子

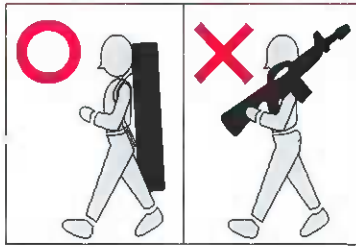

While carrying the soft ballistic gun, make sure the muzzle is tightly covered by the lid, and should be put in the bag or box.
攜帶軟彈槍走路時,安全蓋子一定要蓋住發射口,並貼緊,而且一定要裝入盒子或包子內

WARNING
警告

KEEP IT OUT OF THE TOUCH OF THE LITTLE KIDS.
請保管在小孩觸手不及的場所

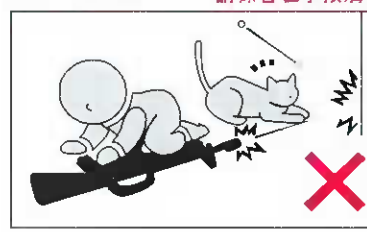

Please put it in the bag or box with the safe lid covered while not using it. And make sure to keep it out of the touch of kids that below 10.
不使用時,一定要將安全蓋蓋住發射口,放入盒子或包子中,並請保管在未滿10歲小孩觸手不及之處

WARNING
警告

YOU CAN CONDUCT BB BALLETS EVEN THOUGH THE BALLISTIC BOX.
即使取下子彈匣,也有可能發射BB彈

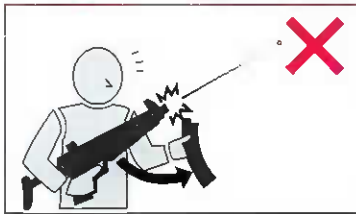

The BB bullets may probably leave in the gun body even you take away the ballistic box, which is very dangerous. So please cover the muzzle with the safe lid after taking away the ballistic box.
即使取下子彈匣, BB彈也有可能殘留在槍機中,非常危險。取下子彈匣后,請將安全蓋蓋住發射口

WARNING
警告

PLEASE COVER IT WITH STICKY TAPE.
請將膠紙封住



Cover the muzzle with the safe lid. Attach the sticky paper to anywhere that is possible to conduct shooting. Please take away the ballistic box.
① 將安全蓋蓋住發射口。
② 在有可能造成發射之處貼上膠紙 ③ 請取下

WARNING
警告

DON'T PULL THE TRIGGER EXPECT YOU WANT TO SHOOT.
除發射時以外,手指不能扣動扳機

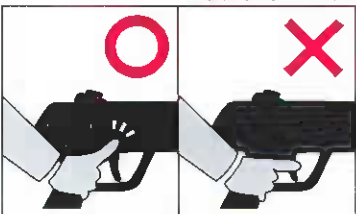

Don't pull the trigger expect you want to shoot. It is very danger if pull trigger because of spring.
除發射時以外,手指不能扣動扳機。如果因為彈力而扣動扳機時,將會非常危險

WARNING
警告

DON'T DISMANTLE THE GUN BODY.
請不要拆散槍機

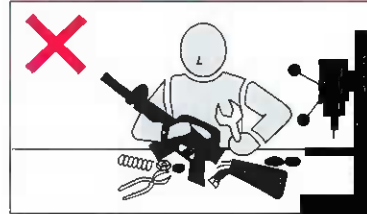

The dismantlement of the gun body would easily cause trouble, incident, which is really dangerous. So please don't dismantle the gun body.
拆散槍機很容易造成故障,事故,非常危險,請絕對不能拆散槍機

WARNING 警告

- THIS SOFT BALLISTIC GUN IS INSTALLED WITH 6MM BB BALLETS WHICH CAN SHOOT IN A DISTANCE OF 50-60M. WHILE USING THIS GUN, YOU HAVE TO CONCERN ALL KINDS OF RISKS, MAKE SURE TO USE IT IN A ABSOLUTE SAFE CONDITION.
- WHILE PLAYING GAMES, PLEASE MAKE SURE THE SAFE CONDITION WHERE THE BB BALLETS MAY POSSIBLY REACH. MAKE SURE THE SECURITY OF THAT THOSE WHO DON'T WEAR PROTECTION GLASSES OR THE SPECTATORS.
- THE MUZZLE SHOULD NOT BE DIRECTED AT GLASS, BULB, FLUORESCENT LAMP, OR HOUSE MACHINE, TEA SET, OR PLATE, FURNITURE, GAS BOTTLE ETC. BECAUSE OF THE DANGER CAUSED BY BROKEN.
- EXCEPT BB BALLETS, NOTHING CAN BE PUT INTO BALLISTIC BOX AND SHOOTING MACHINE.
- THE FINGER CAN INSERT INTO CERTAIN SPOT ACCORDING TO THE SHAPE OF GUN, BUT PLEASE DON'T PUT YOUR FINGER INTO THE GAP OF THE GUN BODY.
- MAKE SURE THE GUN IS PLACE IN THOSE PLACE WHERE IS NOT EASY TO FALL, AND SHOULD BE OUT OF THE REACH OF THE KIDS BELOW 10. WHAT'S MORE, IN ORDER TO PREVENT THE NAUGHTY KIDS, THE MUZZLE SHOULD BE COVERED WITH SAFE LID, AND SHOULD BE PUT IN BAG OR BOX.
- WHEN YOU FOLLOW THE RIGHT WAYS (ACCORDING TO THE INSTRUCTION), BUT STILL CAN SHOOT BB BALLETS; OR WHEN YOU CAN REPAIR BECAUSE OF THE BREAKDOWN CAUSED BY THE GETTING OLD, OR THE FALL DOWN CAUSED BY THE WRONG OPERATION, PLEASE SEND TO THE STORE WHERE YOU GET IT OR MAIL IT TO HAVE IT REPAIRED.
- IF YOU OPERATE PROPERLY, IT CAN CONDUCT 1000 ROUNDS OF BALLETS, AND THE ACCESSORIES CAN BE REPLACED. IF YOU CAN'T DO IT, THAT MEANS THERE IS SOMETHING WRONG IN IT. PLEASE SEND IT TO THE STORE WHERE YOU GET IT OR MAIL IT TO HAVE IT EXAMINED OR CHANGE THE PARTS.

- 此軟彈槍安裝的6毫米的BB彈能飛出50~60米,使用時要考慮各種危險,應在十分安全下才能使用。
- 玩遊戲時,要確認BB彈可能射到之處的安全,注意沒有戴護目鏡的人和不參加遊戲的人的安全。
- 因有破碎、損壞的危險,發射口絕對不能對著玻璃、日光燈、電燈、家庭用電氣品、茶具及盤子等、家具、自動、氣瓶等發射。
- 子彈匣和發射器,除BB彈外不能放入其他物品
- 此槍機的形狀,手指等可能插入某處,請注意手指一定不能插入槍機的間隙。
- 擺放槍機的地方一定是不易掉落或滾落,並保管在未滿10歲小孩觸手不及之處,另外,為防止小孩搗蛋,發射口一定要用安全蓋蓋住,而且要裝進袋子或盒子內。
- 正確使用方法(按說明書),但不能發射BB彈時,可因變舊而引起的故障,錯誤使用引起的掉落等自己無法修改時,請務必拿到所購買的商店維修。
- 正確使用此槍機約能發1000發,還能更換配件,如果不能的話說明裡面有故障,請拿到所購買的商店檢查或更換配件。

- Various types of scopes and dot sights can be selected and used according to your applications. Refer to instruction manuals of respective parts to mount them correctly when installing selected parts.

根據您的需要選擇并使用不同類型的瞄準鏡及紅點鏡。
當要安裝所選擇的零件時，請參照各部件的使用說明書正確地安裝各個零件。

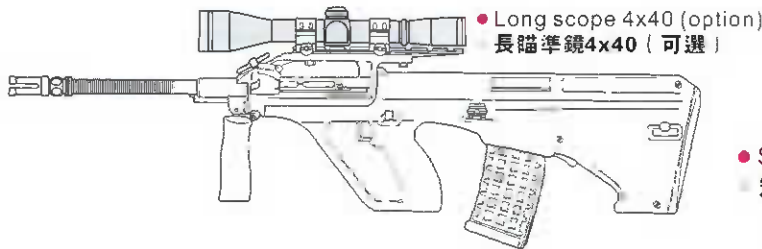

- Short scope 3x20 (option) 短瞄準鏡3x20 (可選)
- Mount ring set (option) 鏡座套件 (可選)



CAUTION Always use genuine parts for the optional scope. We shall not be responsible for any malfunctions and accidents arising from use of other scope or optical devices.

注意 請始終為可選瞄準鏡選擇真正的零件。
如因使用其它瞄準鏡或瞄準器而引起的故障及事故，我們公司將概不負責。

- Dot sight (option) 紅點鏡 (可選)



- Dot sight mount ring (for electric gun) (option) 紅點鏡鏡座套 (用于電子槍) (可選)

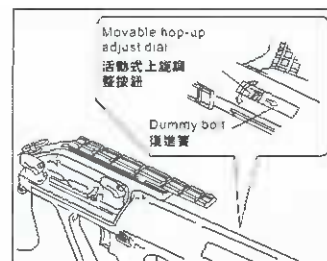
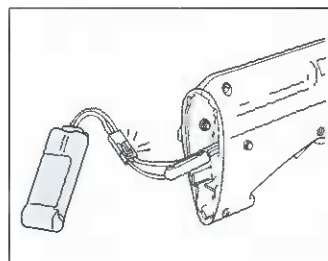
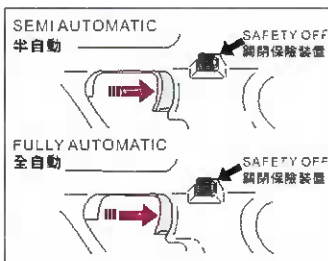

- Semi/Auto selection by trigger pulling distance 通過扣動扳機的距離來控制選擇半自動/全自動模式。
- Mini Battery 迷你電池
- Variable hop-up system as standard equipment 作為標準裝置的可變上旋系統
- 330 bullet magazine (option) 330子彈盒 (可選)

DATA OF AU-1G AUTOMATIC ELECTRIC AIR GUN		AU-1G 電動氣槍技術數據	
名稱	Name	狙擊槍 NO.0448A)	SNIPING GUN(NO.0448)
全長	Overall	805毫米	805mm
重量	Weight	3.4千克 (包括電池)	3.4 kg (including battery)
槍管長	Barrel length	510 毫米	510mm
裝彈數	Bullet capacity	330/80發	330/80 rounds
子彈	Bullet	6mm BB 彈	6mm BB bullets
初速	Initial bullet speed	90m/秒	90m/sec (Light-weight bullet)
連射速度	Full auto shooting speed	700~850 發/分	700 to 850 rounds/min
軌幅	Base width	20 毫米	20mm

ELECTRIC AIR GUN, (INSTRUCTION MANUAL)

自動電子氣槍 (使用說明書)



Read through this manual before shooting paying special attention for safe operation.
在開始射擊前應從頭到尾閱讀該使用說明書，特別注意該如何安全操作。

Mr. "M" Age 25
Shooting Instructor
M先生，年齡25歲，
射擊教練

- Thoroughly understand the warnings and cautions for safe operation.
要徹底弄明白該如何安全操作的注意事項及警告。



Always observe warnings and cautions strictly.
請始終嚴格遵守警告及注意事項。
Failing to do so may cause injury, accidents or damage to the gun.
如果做不到上述要求，將可能引起受傷意外或損壞該槍。

Charging the Battery (Battery and charger are options.) 電池充電 (電池及充電器是可選的)

- Use the specified battery for the gun. 8.4V, 600mAH Hyper Command Mini Battery.

使用適用於該槍的指定電池，8.4V, 1050mAH超控迷你電池。
Avoid use of non-standard or other brand name batteries.
避免使用不標準的或其它品牌的電池。
Otherwise, the originally designed functions will not be obtained.
否則，將達不到原設計的各項功能。

The SD and AK Type Mini Batteries cannot be used.

注意： 不能使用SD及AK型號的迷你電池。

- Use the specified battery charger which is applicable to the above battery, the charger Exclusive Type or AC Speed Charger.

使用適用於上述電池的指定電池充電器，指定型號的充電器或Ac快速充電器。

- The battery's capacity power is increased with use of the Ni-cd battery Discharger (Sold separately)

使用鎳鎘電池將提高電池的電容量。放電器 (另購)

- Use the correct battery and charger according to respective instruction manuals. We will not be held responsible for any accident or damage caused by wrongful operation or usage of non-specified batteries.

根據各自的使用說明書正確地使用適當的電池及充電器。
如因錯誤操作或使用非指定電池而引起的意外事故或損害，
我們公司將概不負責。



Use the specified battery.
使用指定的電池。

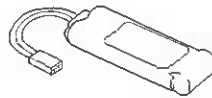

- 8.4V Mini Battery pack
8.4V迷你電池組

- Ni-cd Battery Discharger
鎳鎘電池放電器

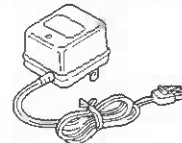

- Exclusive Charger for Mini Battery
迷你電池專用充電器

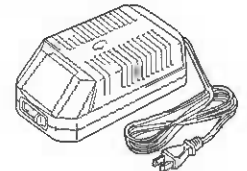

- AC Speed Charger
Ac快速充電器

Component Names (For details, see the name given for each component.)

零件名稱 (詳情請見各零件名稱表)

Open Sight

打開後圖解 8P- 5

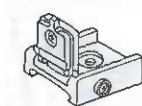

(For front)
(正面)

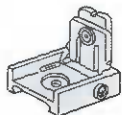

(For rear)
(背面)

Mount Base

瞄準鏡底座 8P- 3 4

Port Cover

退彈孔蓋 8P- 5

Rear Swivel

後吊環

Take-down Latch

可拆卸插銷 11P- 9

Gas Regulator

氣壓調節器 8P- 5

Front Swivel

前吊環

Magazine Catch

子彈盒卡筴

Trigger

扳機 7P- 1 9P- 7

Cocking Handle

壓簧杆把手 8P- 5 11P- 9

Barrel Lock Button

槍管鎖定按鈕 11P- 9

Flash Suppressor

消火器 13P- 注意

Fore Grip

前把手 8P- 5

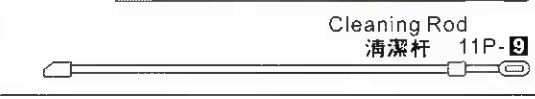
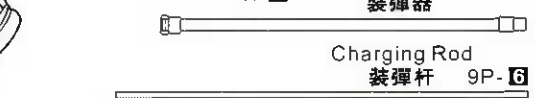
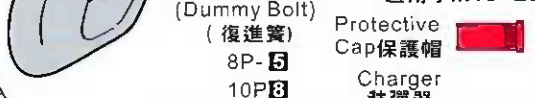
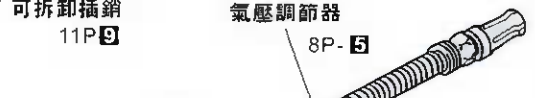

Safety Button

保險裝置按鈕 7P- 1

Ejection Port

退彈孔 (復進簧) 8P- 5 10P- 8

For M16-G3

適用於M16-G3

Protective Cap

保護帽 8P- 5

Charger

裝彈器 10P- 8

Charging Rod

裝彈杆 9P- 6

Cleaning Rod

清潔杆 11P- 9

Butt Plate

槍托底板 7P- 2

Stock

槍托

Magazine

子彈盒 9P- 6

Always attach the protective cap during storage.
收藏時，請始終系上保護帽。



- Never operate the Safety button while pulling the trigger. Otherwise, malfunctions are possible, resulting in accidents.
扣動扳機時，切勿操作保險裝置按鈕。否則將會發生故障并導致意外事故。



- Pulling the trigger furiously with the Safety button being set to ON may damage the gun.
當保險裝置按鈕設置在打開位置時，粗暴地扣動扳機將會損壞該槍。

1. Trigger and Safety Button (Set the Safety to ON until immediately before firing.)

扳機及保險裝置按鈕 (祇在準備射擊時才將保險裝置設置在打開位置)

SAFETY
保險裝置



Always set the Safety to ON when you are not firing the gun or during storage. Also, put on the protective cap without fail.
當你不在射擊或收藏該槍時，請始終將保險裝置設置在打開位置。同時不要忘了系上保護帽。

SEMI AUTOMATIC
半自動



Semi Auto (Single shot) Pulling the trigger to the midway (about 4 mm) fires a single bullet.

半自動 (單發)：扣動扳機一半 (大約4毫米) 射出一發子彈。

FULLY AUTOMATIC
全自動



Full Auto (continuous Shooting) Pulling the trigger all the way (about 7mm) fires bullets continuously while you are pulling the trigger. Releasing the trigger slightly Stops firing.

全自動 (連發)：扣動扳機全部 (大約7毫米)，當你按緊扳機時將連續發射子彈。輕輕鬆開扳機將停止射擊。



- Always attach the protective cap and disconnect the magazine to avoid sudden operation upon connecting the connector to the battery.
當連接電池和連接器時，請始終系上保護帽并卸下子彈盒以避免意外操作。

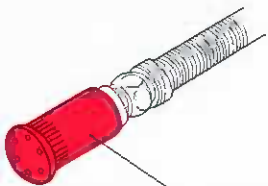

Protective cap
保護帽



- Attach the Butt plate firmly. Otherwise, it may fall off.
緊緊地裝上槍底板。否則，底板可能會掉下來。

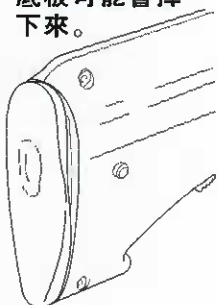

2. Setting the Battery (Conduct operations hereafter after charging the battery)

安裝電池 (將電池充電後執行該操作)

- 1 Remove the Butt plate by pulling it towards you while pinching it inwards as shown.
如圖所示，向內壓緊槍托底板并朝自己把它拉出來以取下底板。

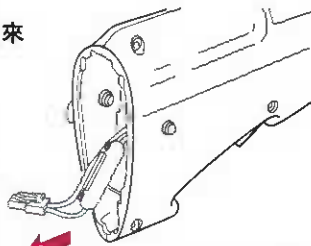
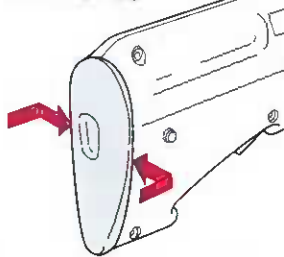

- 3 Firmly set the butt plate by pressing in the bottom, top and side in this order.

按順序緊緊地壓進底部，頂部及表面以裝上槍托底板。

- 2 Connect the connector and place the battery inside the stock.
接上連接器并將電池裝入槍托內。

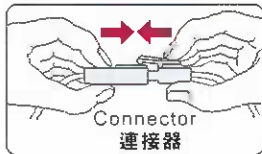

Connector
連接器

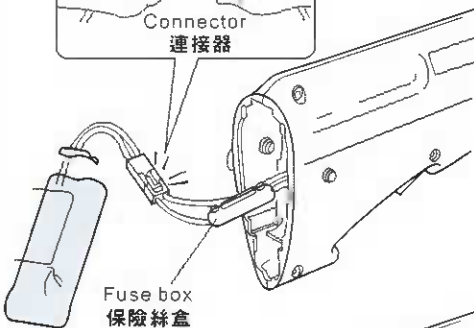

Fuse box
保險絲盒

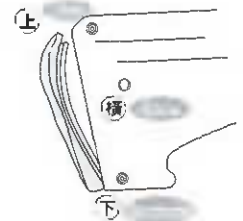
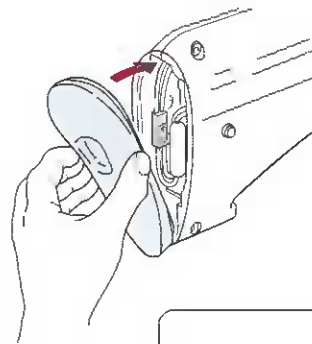

1 CHECK POINT 要點

Set the connector and fuse box in the stock as shown.
如圖所示，將連接器及保險絲盒式裝入槍托內

Carefully place them in position. If the connector and fuse box are piled up against each other, the butt plate may disconnect or the fuse be damaged.

注意：在適當的位置正確地安裝。如果連接器和保險絲盒逆向堆放，槍托底板將斷開連接或者會損壞保險絲。



- Be sure to tighten the sight leaf screw firmly, as it will fall off if it is too loose.
- 要確保擰緊準星片螺絲，如果太鬆，螺絲會掉下來。

3. Setting the Open Sight 安裝開放式照門

Adjustment Procedure 調整方法

Bullets shift upwards 向上移動瞄準子彈孔。
Sight leaf 準星片
Bullets shift rightwards. 向右移動瞄準子彈孔。
Loosen 鬆開
Bullets shift downwards 向下移動瞄準子彈孔。
Bullets shift leftwards. 向左移動瞄準子彈孔。
FRONT 正面

Mounting Procedure 安裝步驟

● Loosen the screws on the side of the open sight. Mount parts for the front and rear to the front rear on mount base, respectively, and tighten the screws.

● 鬆開照門兩邊的螺絲釘。分別裝上前後兩個零件，然後擰緊螺絲釘。

● After mounting, fire bullets to adjust deviation between hitting points and the sight point. Loosen the screw and move the sight leaf to align the hitting point with the sight point, and tighten the screw to fix the leaf.

● 安裝之後，射擊子彈以調整射擊點與瞄準點之間的偏差。鬆開螺絲釘并移動準星片以使射擊點與瞄準點一致，然後擰緊螺絲釘以固定準星片。

※ The open sight may be folded when the gun is not in use.
當不使用該槍時，開放式照門可折疊起來。



- Never look the sun or strong light sources (spot light or head lights) through the scope.
- 切勿透過瞄準鏡去看太陽或強光（如聚光燈或照明燈）。

4. Mounting the Scope 安裝瞄準鏡

Mount base width (20mm). Attach genuine optional long/short scope 4x40-3x20 or dot sight. (referring to page 5.)
鏡座寬（20毫米）裝上純正的長短瞄準鏡 4x40-3x20 或者紅點鏡。（參照第5頁）

Long Scope 4x40 (Option)
長瞄準鏡 4x40 (可選)

Mount Ring (Option)
鏡座套 (可選)

Protective cap 保護帽

<Mounting Position>
安裝位置

● Firmly mount the scope referring to the instruction manual and the figure above.
● 根據上圖及使用說明書，牢固地裝上瞄準鏡。



- Be careful so as not to catch your fingers in the movable parts.
- 注意不要被活動式部件夾傷手指。

5. Movable Parts 活動式部件

Fore Grip 前把手

● Pull the fore grip downwards while pulling it forwards when setting it to the up-right position.
將其垂直安裝時，在向前按住前把手時同時向下按住前把手。

Setting to the up-right position
安裝到垂直位置。

Grasp 把手

● To fold up the fore grip, press it up while pulling it downwards.
● 要將前把手折疊起來時，應在向下拉的同時將其壓向上。

Gas Regulator 氣壓調節器

● Sliding the lever and pressing the nail out of the dent permits to turn the gas regulator.
● 滑動控杆并將釘子壓出凹槽以轉動炮長輔助瞄準鏡調整器。

Pawl 制轉杆

● Setting the cutout at the position shown below permits to remove the regulator to the front.
● 安裝剪切塊到下圖所示的位置可將調整器移動到前面。

Front View 正面圖

Movable hop-up adjust dial 活動式上旋調整按鈕。
Dummy bolt 復進簧

Port Cover 退彈孔蓋

● The port cover may be removed and attached to the right ejection port.
● 退彈孔蓋可被拆下并安裝到正確的退彈孔上。



- Firmly set the port cover. Otherwise, you may lose it during operation.
- 緊緊地裝上退彈孔蓋，否則會在操作中掉下來。



- Always use the BB Bullet for this air gun. We shall not be held responsible for any damage or accidents arising from the use of bullets supplied by other manufacturers.

請始終使用可用于該槍的BB彈。對於使用其他生產商供應的子彈而引起的損壞或意外事故，我們公司將概不負責。



6. Setting the Magazine

安裝子彈盒

- Press the magazine catch to remove the magazine. (Support the magazine as it may drop.)
按下子彈盒卡筍，取下子彈盒 (支撐着子彈盒以防止它掉下來)
- Insert 6mm BB bullets into the charger. (Seventy bullets may be inserted.)
將供應的6MM BB彈裝入裝彈器 (可裝70發子彈)

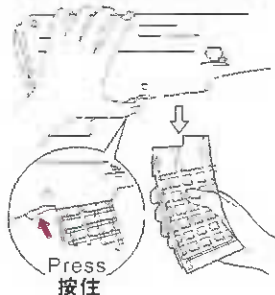

- Make sure to set the magazine upwards and connect it firmly until a click sound is heard.
確保子彈盒朝上并穩固地安裝直到聽到咔嚓聲

- Press in bullets using the charging rod. The magazine is capable of containing 80 rounds. If you want to insert 80 rounds, conduct operations in to again.

用裝彈棒壓入子彈
子彈盒能容納80發子彈
如果你要裝入80發子彈，
請重複操作2~4

Be careful not to press the charging rod excessively to avoid difficulty in loading BB bullets.

注意不可過分按壓裝彈棒，避免裝填BB彈時有困難。



- Insert the charger into the magazine. 將裝彈器插入子彈盒。

- Insert the BB bullet stopper horizontally when inserting the charger into the magazine, to avoid interference with the magazine stopper in the magazine. 將裝彈器插入子彈盒時，水平插入BB彈制動器，避免與子彈盒裏的子彈盒制動器相衝突。



Magazine stopper relief rib 子彈盒制動器解除肋條

Sliding the rib in the arrow direction permits to remove remaining BB bullets. (Be careful as they will jump out.)

按箭頭方向滑動肋條以取出殘留的BB彈。(小心子彈會跳出。)



The projection in magazine is inserted inside the stock. If it remains outside the stock, BB bullets will not be fired. 子彈盒裏的凸出物必須被壓進槍托裏。如果凸出物露在槍托外面，BB彈將無法發射。

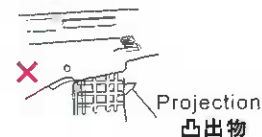

- It is possible from time to time that pulling the trigger fails to fire in semi auto mode. In such a case, set the selector to full auto once, fire 5 to 6 shots and return to the semi auto mode. The gun should then function correctly.

在半自動模式下，有時扣動扳機有可能沒法射擊。在此情況下，將選擇器設置到全自動模式一次，發射5至6發子彈後返回半自動模式。然後該槍的功能將回復正常。



- Smell may be generated from the motor for a while when a new air gun is operated, this is the normal operation of the gun.

當操作新的氣槍時，馬達會產生一陣氣味。這是該槍的正常操作。



- The hopping up operation may be unstable for 200 to 300 rounds after using silicone oil, this is the normal operation of the gun.

使用硅油後，上旋轉作將有200至300發子彈不穩定。這是該槍的正常操作。

7. FIRING (Operate the gun after confirmation of safety.)

射擊 (在確保安全後再操作該槍。)

Protective cap Remove the cap immediately before firing. 保護帽，在即將射擊前才將保護帽取下。

Cautions on Motor and battery 馬達及電池注意事項

- Charge the battery if the firing cycle becomes slow. 當射擊周期變慢時，請將電池充電。
- Give the air gun a rest for 5 to 10 minutes after firing about 500 rounds, in order to ensure long service lives of the motor and battery. 在發射大約500發子彈後，讓氣槍休息5至10分鐘，以使馬達及電池有更長的使用壽命。

When Bullets Are Clogged 子彈阻塞時

- If bullets are clogged, remove clogging bullets (see 9 on page 10 and 12 on page 11) and apply a few drops of silicone oil or spray for 0.5 to 1 sec from the magazine entrance into the chamber (never use CRC-556 or other mineral oils). This ensures smooth firing of bullets. 當子彈阻塞時，取出阻塞的子彈 (參見第10頁的第9點及第11頁的第9點的第(2)小點) 并滴幾滴硅油或從子彈盒口向槍膛裏噴0.5至1秒。(切勿使用CRC-556或者其他礦物油。) 這能確保子彈的順利發射。

After Operation 操作之後

- Remove the magazine and dry fire the gun in the semi auto mode directing the muzzle to a safe direction. (Otherwise, the spring may be weakened.) 卸下子彈盒，在半自動狀態下，將槍口對準安全方向空射 (否則，將損壞彈簧。)
- Bullets may remain in the chamber even if the magazine contains no bullets (or if the magazine is not connected). (Two or three bullets may drop from the magazine, this is the normal operation of the gun.) 即便子彈盒裏沒有子彈 (或者沒有裝上子彈盒)，子彈都有可能留在槍膛裏。(可能從子彈盒裏掉出兩三顆子彈，這是該槍的正常操作。)
- Always disconnect the battery and attach the protective cap whenever you do not operate the air gun. 每當你不操作該氣槍時，請始終取出電池并系上保護帽。

Always attach the protective cap during storage. 收藏時，請始終系上保護帽。

- Set the safety button to OFF. 將保險裝置按鈕設置在OFF狀態。

- Pull the trigger. 扣動扳機。

A blank firing may occur at triggering after setting the magazine, this is the normal operation of the gun.

注意：安裝好子彈盒後，觸發時會發生空射。這是該槍的正常操作。

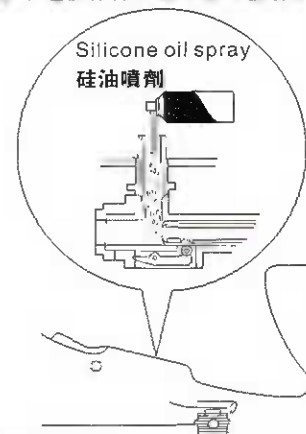

Always use the genuine 0.2g BB bullet for Electric Gun.
請始終使用適用於電子槍的真正的0.2克BB彈。



● If the hop-up is adjusted excessively causing clogging of bullets, immediately stop operating the gun, return the dial to Normal, fire 2 or 3 shots and readjust.

如果上旋過分調整會導致子彈阻塞，請立即停止操作該槍，將旋鈕調整至正常模式，發射2至3發子彈後再重新調整。



● Since a precision tight barrel is used, use of dirty bullets or those with burrs causes clogging of bullets and possible fatal damage to the mechanical box and system.

因為使用的是精確密封的槍管，如使用不幹淨的子彈或帶毛頭的子彈會引起子彈阻塞或可能嚴重損壞機械盒及系統。



● Never hold the gun side ways as the BB bullets will curve right or left. This is due to the HOP-UP system. 切勿握著槍側向一邊發射，BB彈會向左或向右彎曲射出，這是因為上旋系統的原故。

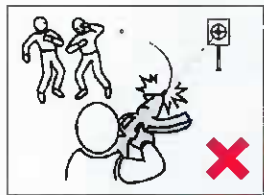

8. Variable Hop Up System 可變式上旋系統

By producing a back-spin on the BB bullets, this system allows for straighter and longer distance shooting than normal air guns. Unlike the fixed type, the variable hop up system permits one-touch adjustments using the dial and lever, making it an ideal hop up system.

使BB彈產生回旋，此系統讓該氣槍比其它的氣槍射得更直，更遠。不像其它的固定型號，可變上旋系統允許通過旋鈕及控制杆進行一觸式調整，使其成為理想的上旋系統。

10. Adjustment Procedure (Adjust by carrying out trial firing, referring to 7 on page 9 of the instruction manual.)

調整步驟（通過嘗試射擊進行調整，參見使用期說明書的第9頁第7點。）

(Make sure to read through this page if you purchased the hop-up version.)

(如果你買的是上旋版本，請確保從頭到尾讀一遍該頁。)

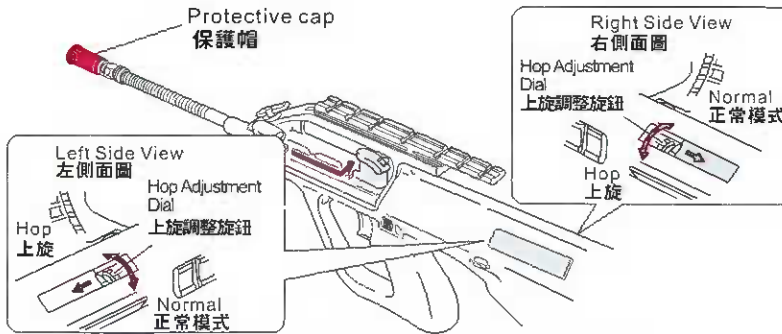

● Gradually turn the adjustment dial towards hop to give hop up bullets. (The best setting is where bullets fly horizontally.)
逐漸向上旋位置轉動調整旋鈕使子彈上旋。（最佳設置位置是子彈水平射出時。）

● Turning excessively adversely affects the trajectory. So stop turning the dial when bullets fly horizontally.
過分地向反方向轉動將影響射擊的軌道。因此，當子彈水平飛出時，請停止轉動旋鈕。

最佳位置是當子彈水平飛出時的位置，并能獲得最長的射擊距離。

● The best position is where the bullets fly horizontally, and the longest flying distance is obtained.

✗ Excessive hop up (Turn the dial towards Normal)
過分上旋（將旋鈕轉動至正常位置。）

○ Best position
最佳位置

○ No hop up (Gradually turn the dial toward Hop.)
沒有上旋（逐漸朝向上旋位置轉動旋鈕。）

✗ Or, excessive hop up (Turn the dial towards Normal.)
如果過分上旋（將旋鈕轉動至正常位置。）

Protective cap (Remove the cap only when you are ready to fire)

保護帽（祇在你準備射擊時才能取下保護帽。）

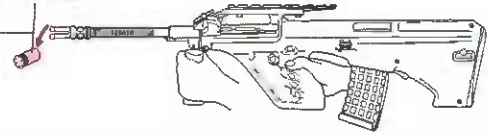

(Strictly observe the following cautions.)
(嚴格遵守以下注意事項。)

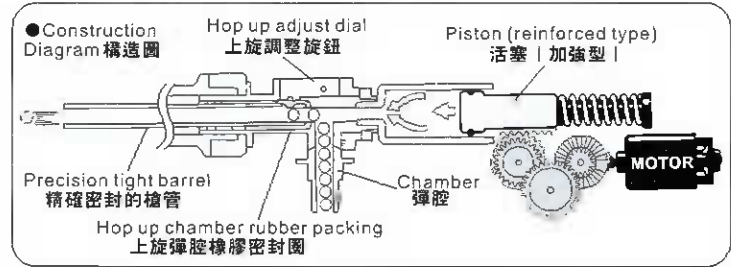

● Turning the hop dial excessively causes clogging of bullets. Keep pulling the trigger with bullets being clogged damages the piston and gears.
過分轉動上旋旋鈕將導致子彈阻塞。當子彈阻塞時，連續扣動扳機將損壞活塞和齒輪。

● If bullet clogging occurs, immediately stop firing the gun, return the hop dial to the Normal position and remove clogging bullets using the cleaning rod. (See 13 on page 11.)
當發生子彈阻塞時，請立即停止射擊該槍，並將上旋旋鈕轉回正常位置，然後用清潔杆取出阻塞的子彈。（參見第11頁第9點的第(2)小點。）

● Make sure to return the hop dial to the Normal position when removing clogged bullets or cleaning. (Otherwise, the chamber packing is damaged.)
當要取出阻塞的子彈或清潔時，請確保將上旋旋鈕轉回正常位置。否則，會損壞彈腔密封圈。

● Never use used and dirty bullets. (Otherwise, the chamber becomes dirty, resulting in instable hopping up.)
切勿使用已用過的或不幹淨的子彈。（否則會弄臟彈腔並導致上旋不穩定。）

● When about 10,000 rounds are fired, spray silicone oil to the chamber for 0.5 to 1 sec. (See 7 on page 8. The hopping up operation may be instable for 200 to 300 rounds after spraying the silicone oil, which is not a problem.)
發射10,000發子彈後，向彈腔內噴0.5至1秒硅油。（參見第8頁的第7點的第3小點。噴射硅油後，上旋操作可能有200至300發子彈不穩定。這不是問題。）

● We shall not be responsible for any damage or accidents arising from wrong operation, disassembly and modification of the air gun. Any costs for repair of such damage shall be paid by the user.
對於錯誤操作或分解、改裝該氣槍而造成的損害或意外事故，我們公司將概不負責。造成損害的任何費用將由使用者負責。

對於錯誤操作或分解、改裝該氣槍而造成的損害或意外事故，我們公司將概不負責。造成損害的任何費用將由使用者負責。

When Hopping Up is Improper 上旋出錯時

Symptom 癥狀	Cause 原因	Action 解決辦法
Bullets flying upwards 子彈向上飛	Too much hop setting 太多上旋設置	Gradually return hop dial towards Normal. 逐漸將上旋旋鈕調回正常位置。
Short flying distance of bullets (less hopping up effect) 短的子彈飛行距離（較少的上旋效果）	Too much hop setting 太多上旋設置	Gradually return hop dial towards Normal. 逐漸將上旋旋鈕調回正常位置。
	Hop packing contaminated by oil or dirt 被油或灰塵污染的上旋密封圈	Fire bullets equivalent to 4 to 5 magazines or clean the chamber using cleaning rod. 發射4至5盒子彈或者用清潔杆清潔彈腔。
	Worn or damaged hop packing 磨損的或破損的上旋密封圈	Purchase the replacement part at your dealer or from and replace it. 向你的購買商或公司購買代換部件并更換。

Symptom 癥狀	Cause 原因	Action 解決辦法
Cannot adjust 不能調整	Damaged adjustment dial or other parts 調整旋鈕或其它零件被損壞	Purchase the necessary replacement part at your dealer and repair. 向你的購買商或公司購買必需的代換零件並進行修理。
Frequent bullet clogging 經常發生子彈阻塞	Too much hop setting 太多上旋設置	Gradually return hop dial towards Normal. 逐漸將上旋旋鈕調回正常位置。
	Improper or too large size BB bullets 不合適的或太大號的BB彈	Use the BB Bullet supplied by us. 使用本公司的BB彈。
	Dirty hop packing 不幹淨的上旋密封圈	Clean using the cleaning rod or consult your dealer for repair 用清潔杆進行清潔或者請教你的購買商或公司進行修理。



● Attach or detach the barrel assembly and receiver with the magazine being removed. Otherwise, bullets remaining in the magazine may jump out to the stock, causing malfunctions.

在取下彈盒時，裝上或拆下槍管組裝部件或承受器。否則，殘留在子彈盒裏的子彈可能跳進槍托裏而引起故障。



● Slowly attach or detach the barrel assembly and receiver. Attaching or detaching rapidly or applying excessive force may cause malfunctions.

慢慢地裝上或拆下槍管組裝部件或承受器。快速地裝上或拆下或者用力過度都可能引起故障。



● Be careful since it will be difficult to remove the receiver or the take-down latch may disconnected from the stock if the take-down latch is pressed excessively beyond the point a click sound is generated.

注意，因為拆下承受器會有點困難或可拆卸插銷會與槍托分離，如果可拆卸插銷被過度按壓超出確定的位置，將聽到咔嚓聲。

9. Normal Disassembly for Overhaul and Maintenance Procedures

檢修或維修過程的正常拆卸

Removal of Barrel Assembly 槍管組裝部件的拆卸

1 Pull the cocking handle and hook it to the receiver nail. (See 5 on page 8.)
拉動壓簧杆把手并用承受器釘子鉤住它。（參見第8頁第5點。）

2 Press down the barrel lock button at an angle and maintain it there.
按一定角度壓下槍管鎖按鈕并保持該狀態。

3 Viewing from the front, turn the barrel assembly counterclockwise (about 20 degrees).

從正面看，逆時針轉動槍管組裝部件（大約20度）。

4 Slowly pull out the barrel assembly to the front.

慢慢將槍管組裝部件拉出來并拉到前面
Key Points for Barrel Assembly Installation
槍管組裝部件安裝要點

● Install the barrel assembly in the reverse order of the above removal procedure.

按上述拆卸步驟的相反順序安裝槍管組裝部件

● Press in the barrel assembly, aligning the projection in the assembly with the cutout in the receiver.

將組裝部件上的凸出物對準承受器上的剪切塊，然後壓進槍管組裝部件

● Turn the barrel assembly so that the rib of the assembly is located at the front edge of the receiver.

轉動槍管組裝部件以使組裝部件的肋條設置在承受器的前邊緣

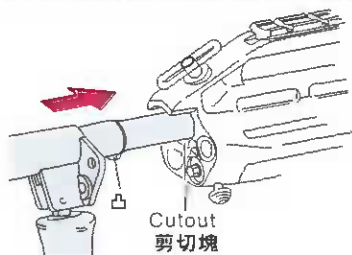

Removal of Receiver 拆下承受器

1 Press the take-down latch from the circle marked position to a position a click sound is generated (about 1 cm). (Be careful not to press it too much.)

從圓圈標記裏按下可拆卸插銷直到聽到一聲咔嚓響。（大約1厘米）（注意不要過分按壓。）

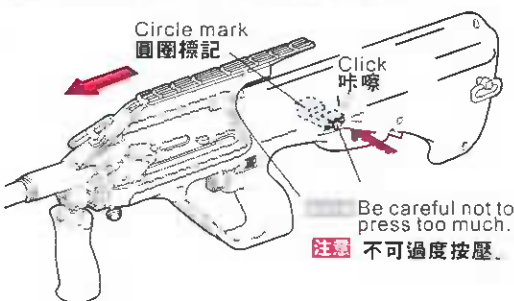

Key Points for Receiver Installation 承受器安裝要點

● Install the receiver in the reverse order of the above removal procedure.

按上述拆卸步驟的相反順序安裝承受器

● Press the take-down latch from the place without a circle mark while pressing the receiver into the stock until there is no gap between them.

將承受器壓進槍托內時，在沒有圓圈標記的地方按下可拆卸插銷直到看不到任何縫隙

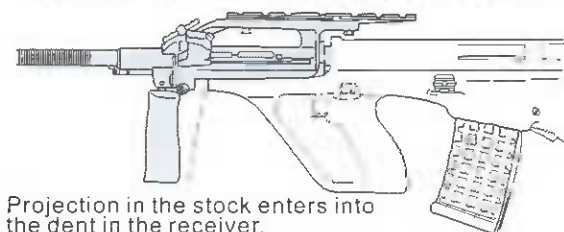

Projection in the stock enters into the dent in the receiver.
槍托裏的凸出物裝在承受器的凹槽裏

CAUTION

Make sure to remove the magazine beforehand.

注意：請確保預先將子彈盒拆下。

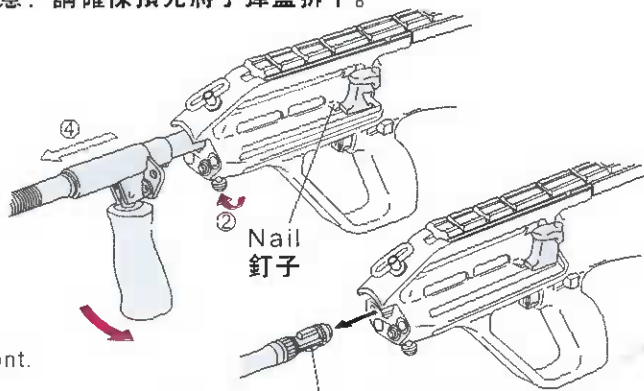

Be careful so as not to damage the chamber.
小心不要損壞彈腔。

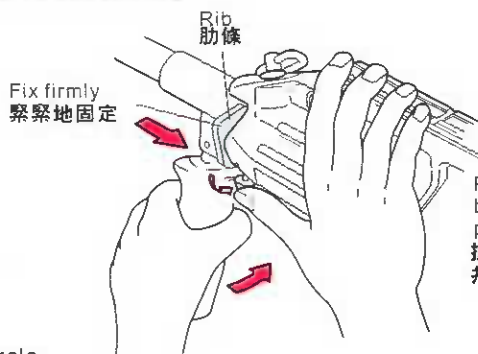

Press the barrel lock button and keep pressing it down.
按下槍管鎖定按鈕并一直將其按下

2 Pull out the receiver towards the front. (Be careful not to hook the projection in the receiver to the spring in the stock and above the trigger.)

向前拉出承受器（注意不要讓槍托裏彈簧鈎到承受器裏的凸出物并鈎到扳機上。）

Be careful so as not to hook the projection to the spring.
注意 不要讓彈簧鈎到凸出物。

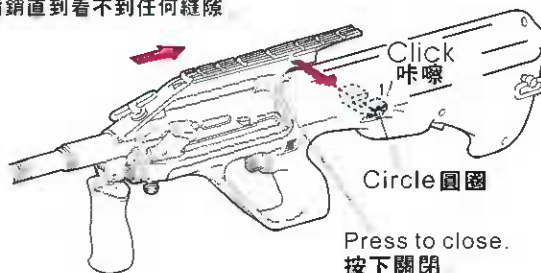
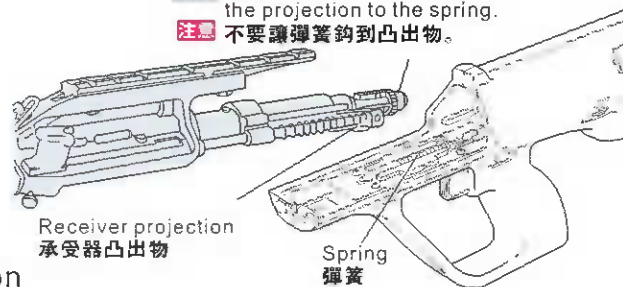



●Begin the maintenance after returning the hop-up dial to the NORMAL (HOP-OFF) position, as in the case of clearing clogged bullets as instructed above.

將上旋旋鈕撥回正常（關閉上旋）位置後進行維修。如上述所示，清除阻塞的子彈。



●Be careful during maintenance. As the inside chamber is precisely designed it can be damaged easily. Use of a hard brush may damage the hop chamber packing.

維修過程要小心，因為其內置彈腔是精密設計的，很容易被損壞。如果使用的是硬刷會損壞上旋彈腔的密封圈。



●Never use any used BB bullets. 切勿使用已用過的BB彈。



●Make sure to insert the cleaning rod AFTER returning the hop up lever to the Normal position. (HOP-OFF)

請確保在將上旋控制杆撥回正常位置（關閉上旋）後再插入清潔杆進行清潔。



●When bullets are clogged, immediately stop operation. Remove clogged bullets and then restart operation of the air gun. (If operation is continued with bullets being clogged, the mechanism may be damaged.)

當子彈阻塞時，應立即停止操作。清除阻塞的子彈後再重新操作該氣槍。如果繼續操作，會損壞機械裝置。

CAUTION Since clogging bullets may jump out at a high speed, always wear safety goggles and confirm safety.

注意：因阻塞的子彈可能快速跳出，請始終戴著安全護目鏡以確保安全。



●The fuse may blow out due to an electrical overcurrent. Malfunctions of the internal mechanism are possible. So, check possible faulty parts and then connect the battery again.

保險絲可能因為過電流而被燒斷，將有可能導致內部機械裝置的故障。因此要先檢查可能出錯的零件再連接電池。

1. Maintenance When Bullet Speed Becomes Low

當子彈速度變慢時的維修

1 Drop a few drops of silicone oil or Teflon oil from the bullet entrance. Insert BB bullets into the magazine and fire bullets equivalent to 1 or 2 magazines.

從裝彈口處滴入幾滴硅油或特氟輪油。將 BB 彈裝入子彈盒可發射 1 至 2 盒子彈。

2 To complete the cleaning, use the cleaning rod (with cotton) as shown below, to remove excess oil.

使用下圖所示的清潔杆（帶棉布）擦掉過多的油，完成清潔。

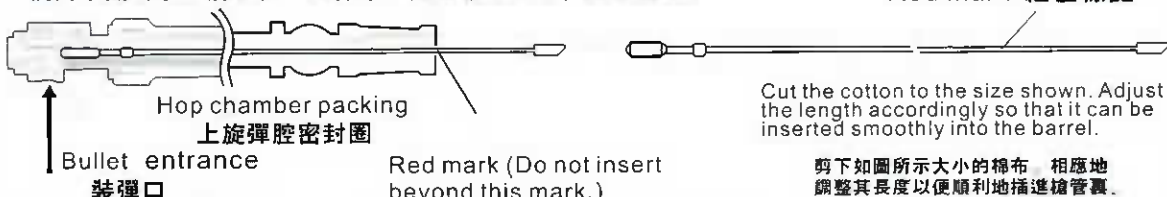

Use a few drops of silicone or teflon oil.

滴入幾滴硅油或特氟輪油。



Hold at the leading end of the rod and insert the rod into the barrel while turning the rod.

握住清潔杆的主前端并插入槍管內然後開始轉動。

2. Remove Clogged Bullets

清除阻塞的子彈

1 Remove the magazine and then the barrel assembly. (See ⑨ on page 11.)

先拆下子彈盒，然後取下槍管組裝部件。（參見第 11 頁第 9 點。）

2 Return the hop up dial to the Normal position and insert the cleaning rod from the lead edge of the barrel. 將上旋旋鈕撥回正常位置，然後將清潔杆從槍管的主前邊緣插入。

3 Be careful so that the angled part of the cleaning rod faces down, and remove clogged bullets.

注意清潔杆的有角部件應朝下，然後清除阻塞的子彈。

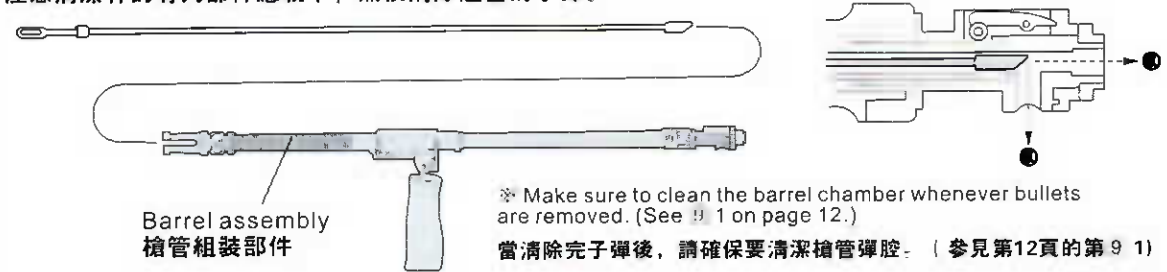

3. Fuse Replacement Procedure

更換保險絲步驟

1 Remove the Butt plate, referring to 1 and 2 of Setting the battery. (7P 2)

取下槍托底板，參見電池安裝的第 1 和第 2。（第 7 頁的第 2）

2 Open the fuse box and replace the fuse.

打開保險絲盒并更換保險絲。

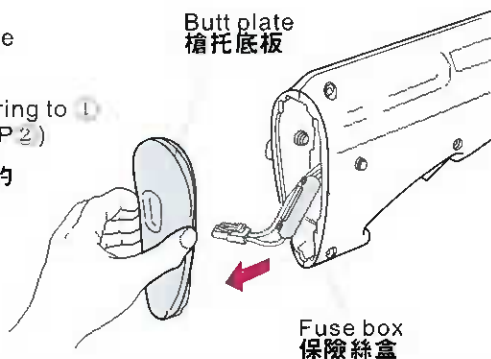

<Glass tube fuse>
玻璃管保險絲

You can buy it at a near-by electric shop or gas station.

你可以在附近的電子商店或加油站買到。

15A Fuse common for electric gun series

用于電子槍系列的普通 15A 保險絲。



CAUTION (Read the instructions below when you want to install the optional full-auto tracer.)

注意 (當你要安裝可選的全自動追蹤器時, 要先閱讀以下的使用說明書。)

● Installing the Full-Auto Tracer Adapter

安裝全自動追蹤器的接合器。

Loosen the set screw located at the flash suppressor using a hexagonal wrench.

用六角形扳手鬆開在消火器上的固定螺絲。



Remove the flash suppressor.

取下消火器



注意螺紋是顛倒的

2 Fix four 2x10 pan head screws.
用4顆2x10平錐頭螺絲固定。



CAUTION

Be careful not to use excessive force when tightening the set screw, to avoid damage of the screw thread.

注意

擰緊固定螺絲時不可用力過度, 以免損壞螺絲釘的螺紋。

1 Remove the silencer lid and tighten set screws for 1 muzzle guide and 2 coupler in this order.

拆下消音器蓋, 按此順序擰緊 1 槍口導向裝置及 2 連接器的固定螺絲。

1 Muzzle guide
槍口導向裝置

2 Coupler
連接器



2x8 pan head screw
2x8平錐頭螺絲

Make sure to tighten the screw starting from this adapter.
請確保從接合器處開始擰緊螺絲。

3 Install the tracer.
安裝追蹤器。

Lid for light emitting unit
發光裝置蓋子

Be careful since the thread is reversed.
注意螺紋是相反的。

Outer case (short)
外殼 (短)

Light emitting unit
發光裝置



10 TROUBLE CLINIC (TROUBLESHOOTING)
故障診所 (故障檢修)

Never use BB bullets other than those supplied by . Use of poor quality BB bullets will cause problems. Never disassemble or modify the gun. 切勿使用除本公司以外的其它生產商供應的BB彈。使用質量較差的BB彈將會引發難題。切勿分解或改裝該槍。

Symptom 癥狀	Cause 原因	Action 解決辦法	Symptom 癥狀	Cause 原因	Action 解決辦法
No operation at all 完全無法操作	Safety button is set to ON 保險裝置按鈕設置在打開位置 Battery is not charged 電池沒有充電 Battery connector is disconnected 電池連接器沒有連接上 The + and - of battery connector is reverse 電池連接器正負極搞錯 Fuse is blown out 保險絲被燒斷 Expired motor life (50,000 to 60,000 bullets) or poor electrical connection 馬達使用壽命期滿 (50,000至60,000發子彈) 或不具電連接	Set the Safety button to OFF 將保險裝置按鈕設置在關閉位置 Charge the battery. 為電池充電 Connect the connector 接上連接器 Connect the connector correctly (check the fuse) 正確地連接上連接器 (檢查保險絲) Replace the fuse (See page 11) 更換保險絲 (參見第11頁) Replace the motor (purchasing from your dealer or us) or check and repair the contacts. 更換馬達 (向你的經銷商或我們購買) 或者檢查并修理接觸器	Failure of semi-auto operation (single shot) 半自動操作失敗 (單發)	Insufficient battery power 電池電量不足 Poor electrical connection 不良的電連接	Charge the battery 給電池充電 Consult your dealer or for overhaul maintenance or repair. 請教你的經銷商或公司進行檢查維修
Although motor is revolving, it doesn't shoot. 儘管馬達會運轉, 卻不能射擊。	Bullets are clogged inside the magazine 子彈阻塞在子彈匣內 Bullets are clogged in the chamber 子彈阻塞在彈腔裏 Faulty gear 齒輪出錯	Insert the cleaning rod into the magazine and move up and down a few times to remove clogged bullets. 將清潔杆插入子彈匣并上下移動幾次以清除阻塞的子彈 Remove clogged bullets using the cleaning rod. (See page 11) 使用清潔杆清除阻塞的子彈 (參見第11頁) Purchase the replacement gear from your dealer or us and repair. 向你的經銷商或我們購買替換的齒輪然後進行修理	Automatic firing cycles become long 自動射擊周期變長	Insufficient battery power 電池電量不足 Worn or damaged chamber packing 磨損的或破損的彈腔密封圈	Charge the battery 給電池充電 Consult your dealer or us for overhaul maintenance or repair. Replace chamber packing, piston packing (O-ring) and piston assembly. 請教你的經銷商或公司進行檢查維修。更換彈腔密封圈, 活塞密封圈 (O型圈) 及活塞組裝部件
Failure of full-auto operation (automatic firing) 全自動操作失敗 (自動射擊)	Trigger is not pulled all the way 扣動扳機不到位 Insufficient battery power 電池電量不足 Faulty bullet feed of magazine 子彈盒送彈出錯 Poor electrical connection 不良的電連接	Pull the trigger all the way 全程扣動扳機 Charge the battery 給電池充電 Repair clogging of the magazine 修理阻塞的子彈盒 Consult your dealer or us for overhaul maintenance or repair. 請教你的經銷商或我們進行檢查維修	Shooting distance becomes shorter. 射擊距離變短	Worn or damaged piston packing (O-ring) 磨損的或破損的活塞密封圈 (O型圈) Deteriorated piston spring 活塞彈簧退化 Faulty BB bullets (too small or heavy) BB彈出錯 (太小或太重) Shortage of silicone oil 缺乏硅油	Use the genuine BB bullets 使用純正的BB彈 Drop a few drops of silicone oil from under the chamber 從彈腔下滴入幾滴硅油 Consult your dealer or us for overhaul maintenance part replacement (gear, etc.) or repair 請教你的經銷商或我們進行檢查維修及零件更換 (如齒輪等)。
Failure of semi-auto operation (single shot) 半自動操作失敗 (單獨射擊)	Deviation in gear timing 齒輪調運出現偏差	Operate in semi-auto after firing 5 to 6 bullets in full-auto by pulling the trigger all the way. 在半自動模式下, 發射5至6發子彈, 然後在全自動模式下, 全程扣動扳機	Excessive noise from gun 槍支發出過多噪音 Bullets falling out from barrel end 子彈從槍管尾掉出來	Worn or damaged gear 磨損的或破損的齒輪 Gear problem caused by too many blank firing 太多次空射而引起的齒輪問題 Worn or damaged chamber packing 磨損的或破損的彈腔密封圈 Faulty BB bullets (too small) BB彈出錯 (太小)	Consult your dealer or us for overhaul maintenance part replacement (gear, etc.) or repair 請教你的經銷商或我們進行檢查維修及零件更換 (如齒輪等)。 Use the genuine BB bullet. 使用純正的BB彈
			If the gun get wet 如弄濕槍支	Stop operation immediately, disconnect the battery, wipe off water from inside the main body, and the battery, and, after complete dry, carry out trial firing. If no operation or malfunction is detected, consult your dealer or us for repair. 立即停止操作并取出電池, 將主體腔裏及電池上的水擦掉, 等完全幹後, 進行試射。如果不能操作或發現故障, 請教你的經銷商或我們進行修理	

11 AU-1G DETAIL LIST

AU-1G 零件清單

Magazine 子彈盒

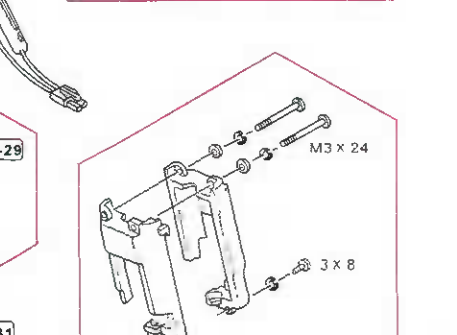
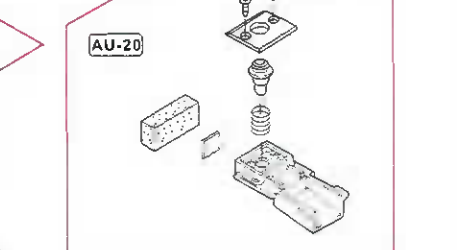
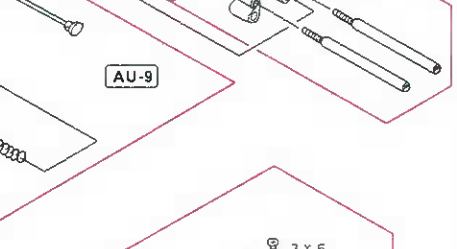
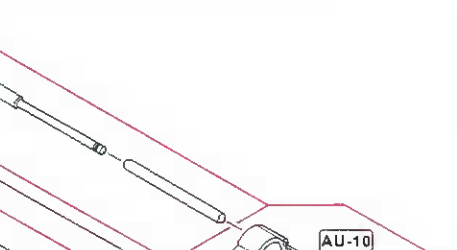
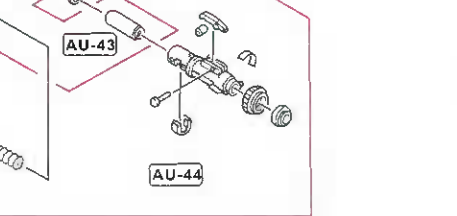
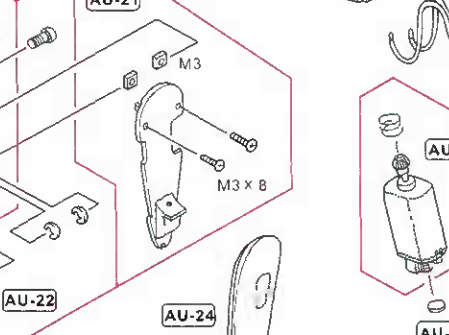
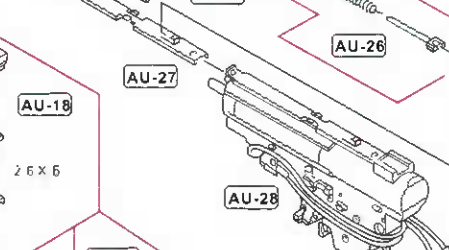
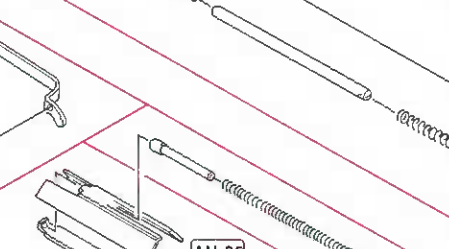
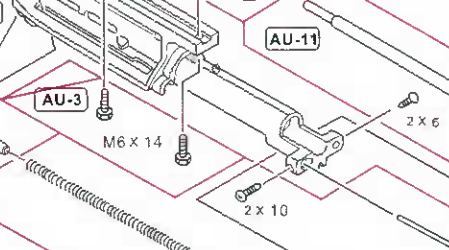
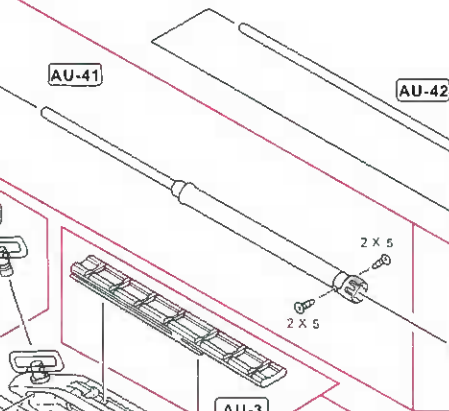
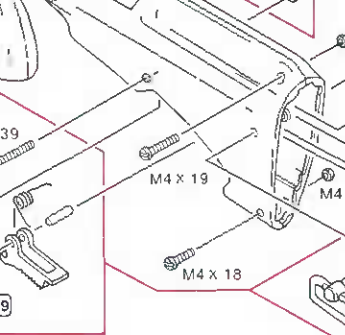
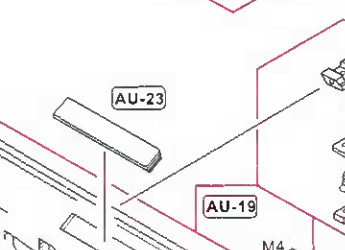
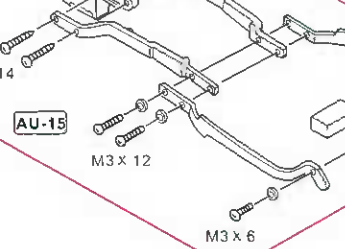
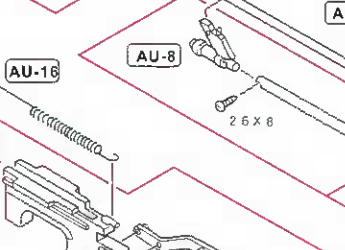
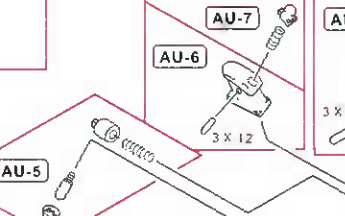
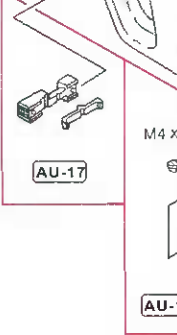
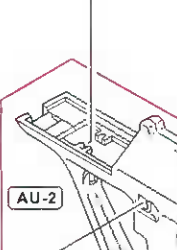
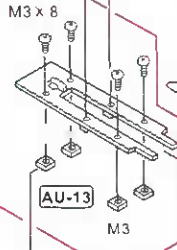
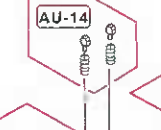
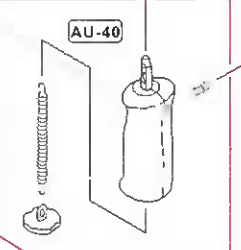
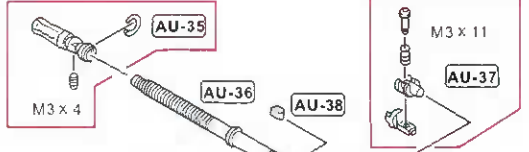
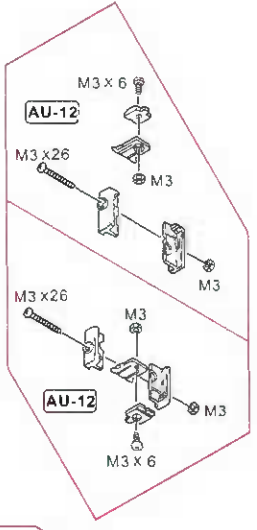
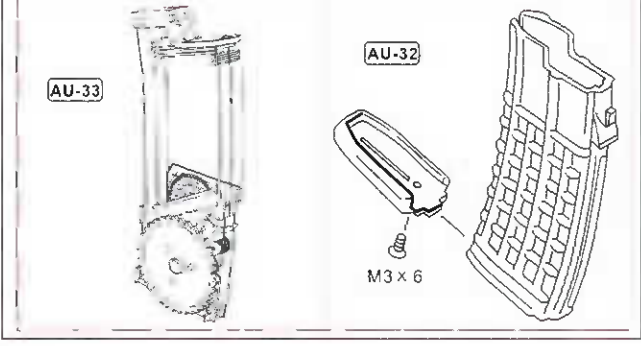

**AUTOMATIC ELECTRIC
GUN SERIES**